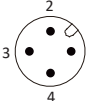

G08 SERIES

ARTICLE PROPERTIES

SENSOR TYPE	Inductive sensor	CONNECTION TYPES (see table)
SIZE	M8x1	<ul style="list-style-type: none"> • cable PVC, 0.34 mm², 2 m** • M8 connector, A-coded 
RATED OPERATING DISTANCE	see table	<ul style="list-style-type: none"> • M12 connector, A-coded 
NUMBER OF CONDUCTORS	2-wire / 3-wire (see table)	** other cable lengths are available on request

MECHANICAL DATA

MOUNTING (mounting nuts included in delivery)	flush/non-flush (see table)
HOUSING	threaded cylindrical
MATERIAL HOUSING	brass nickel-plated
MATERIAL SENSING SURFACE	PBT
TIGHTENING TORQUE	2 Nm
LOCKING	
STANDARD TEST	FE360
ATTENUATION COEFFICIENT	St37 = 1, V2A = 0.7, Al = 0.3

ELECTRICAL DATA

OPERATING VOLTAGE	DC: 10 ... 30 V DC
RATED OPERATING CURRENT	2-wire DC: ≤ 100 mA 3-wire: ≤ 200 mA
SWITCHING FREQUENCY	see table
SWITCHING OUTPUT	see table
FUNCTION INDICATOR	red LED
HYSTERESIS	3 ... 15 %
TEMPERATURE DRIFT	±10 %
SHORT-CIRCUIT PROTECTION	yes
OVERLOAD RESISTANCE	yes
REVERSE POLARITY PROTECTION	yes

ENVIRONMENTAL CONDITIONS

PROTECTION CLASS	IP68	VIBRATION RESISTANCE (EN 60068-2-27)	55 Hz, 1 mm
AMBIENT TEMPERATURE	-30 ... 85 °C	SHOCK RESISTANCE (EN 60068-2-6)	30g/11 ms

STANDARDS AND DIRECTIVES

LOW-VOLTAGE SWITCHGEAR AND CONTROLGEAR	DIN EN IEC 60947-5-2:2021-04
---	------------------------------

APPROVALS



G08 SERIES

DC 2-WIRE OUTPUT CABLE

Article number	Mounting	Rated operating distance Sn	Switching output (wiring diagram)	Switching frequency	Dimensions
Fi2-G08-OD6L	flush	2 mm	DC NO (WD1)	800 Hz	see Fig. 1
Fi2-G08-CD6L	flush	2 mm	DC NC (WD2)	800 Hz	see Fig. 1
Ni4-G08-OD6L	non-flush	4 mm	DC NO (WD1)	600 Hz	see Fig. 2
Ni4-G08-CD6L	non-flush	4 mm	DC NC (WD2)	600 Hz	see Fig. 2

DC 2-WIRE OUTPUT M8 CONNECTOR

Article number	Mounting	Rated operating distance Sn	Switching output (wiring diagram)	Switching frequency	Dimensions
Fi2-G08-OD6L-Q8	flush	2 mm	DC NO (WD1)	1200 Hz	see Fig. 3
Fi2-G08-CD6L-Q8	flush	2 mm	DC NC (WD2)	1200 Hz	see Fig. 3
Ni4-G08-OD6L-Q8	non-flush	4 mm	DC NO (WD1)	750 Hz	see Fig. 4
Ni4-G08-CD6L-Q8	non-flush	4 mm	DC NC (WD2)	750 Hz	see Fig. 4

DC 2-WIRE OUTPUT M12 CONNECTOR

Article number	Mounting	Rated operating distance Sn	Switching output (wiring diagram)	Switching frequency	Dimensions
Fi2-G08-OD6L-Q12	flush	2 mm	DC NO (WD1)	1200 Hz	see Fig. 5
Fi2-G08-CD6L-Q12	flush	2 mm	DC NC (WD2)	1200 Hz	see Fig. 5
Ni4-G08-OD6L-Q12	non-flush	4 mm	DC NO (WD1)	750 Hz	see Fig. 6
Ni4-G08-CD6L-Q12	non-flush	4 mm	DC NC (WD2)	750 Hz	see Fig. 6

DC 3-WIRE OUTPUT CABLE

Article number	Mounting	Rated operating distance Sn	Switching output (wiring diagram)	Switching frequency	Dimensions
Fi2-G08-OP6L	flush	2 mm	PNP NO (WD7)	1400 Hz	see Fig. 1
Fi2-G08-ON6L	flush	2 mm	NPN NO (WD8)	1400 Hz	see Fig. 1
Fi2-G08-CP6L	flush	2 mm	PNP NC (WD9)	1400 Hz	see Fig. 1
Fi2-G08-CN6L	flush	2 mm	NPN NC (WD10)	1400 Hz	see Fig. 1
Ni4-G08-OP6L	non-flush	4 mm	PNP NO (WD7)	750 Hz	see Fig. 2
Ni4-G08-ON6L	non-flush	4 mm	NPN NO (WD8)	750 Hz	see Fig. 2
Ni4-G08-CP6L	non-flush	4 mm	PNP NC (WD9)	750 Hz	see Fig. 2
Ni4-G08-CN6L	non-flush	4 mm	NPN NC (WD10)	750 Hz	see Fig. 2

G08 SERIES

DC 3-WIRE OUTPUT M8 CONNECTOR

Article number	Mounting	Rated operating distance Sn	Switching output (wiring diagram)	Switching frequency	Dimensions
Fi2-G08-OP6L-Q8	flush	2 mm	PNP NO (WD7)	1400 Hz	see Fig. 3
Fi2-G08-ON6L-Q8	flush	2 mm	NPN NO (WD8)	1400 Hz	see Fig. 3
Fi2-G08-CP6L-Q8	flush	2 mm	PNP NC (WD9)	1400 Hz	see Fig. 3
Fi2-G08-CN6L-Q8	flush	2 mm	NPN NC (WD10)	1400 Hz	see Fig. 3
Ni4-G08-OP6L-Q8	non-flush	4 mm	PNP NO (WD7)	750 Hz	see Fig. 4
Ni4-G08-ON6L-Q8	non-flush	4 mm	NPN NO (WD8)	750 Hz	see Fig. 4
Ni4-G08-CP6L-Q8	non-flush	4 mm	PNP NC (WD9)	750 Hz	see Fig. 4
Ni4-G08-CN6L-Q8	non-flush	4 mm	NPN NC (WD10)	750 Hz	see Fig. 4

DC 3-WIRE OUTPUT M12 CONNECTOR

Article number	Mounting	Rated operating distance Sn	Switching output (wiring diagram)	Switching frequency	Dimensions
Fi2-G08-OP6L-Q12	flush	2 mm	PNP NO (WD7)	1400 Hz	see Fig. 5
Fi2-G08-ON6L-Q12	flush	2 mm	NPN NO (WD8)	1400 Hz	see Fig. 5
Fi2-G08-CP6L-Q12	flush	2 mm	PNP NC (WD9)	1400 Hz	see Fig. 5
Fi2-G08-CN6L-Q12	flush	2 mm	NPN NC (WD10)	1400 Hz	see Fig. 5
Ni4-G08-OP6L-Q12	non-flush	4 mm	PNP NO (WD7)	750 Hz	see Fig. 6
Ni4-G08-ON6L-Q12	non-flush	4 mm	NPN NO (WD8)	750 Hz	see Fig. 6
Ni4-G08-CP6L-Q12	non-flush	4 mm	PNP NC (WD9)	750 Hz	see Fig. 6
Ni4-G08-CN6L-Q12	non-flush	4 mm	NPN NC (WD10)	750 Hz	see Fig. 6

G08 SERIES

DIMENSIONS

Fig. 1 Inductive sensor with cable (flush)

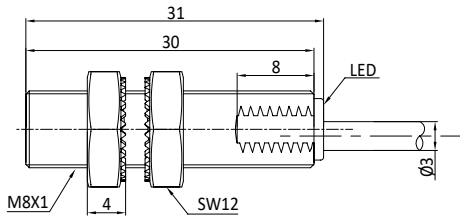

Fig. 2 Inductive sensor with cable (non-flush)

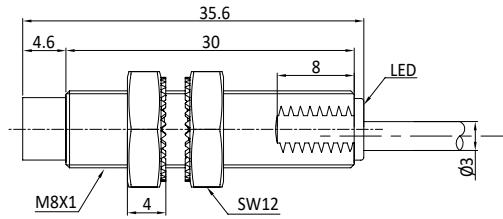

Fig. 3 Inductive sensor with M8 connector (flush)

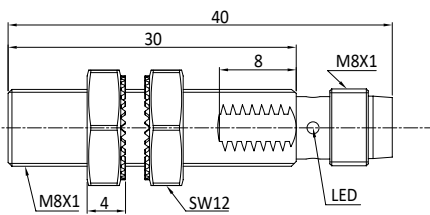

Fig. 4 Inductive sensor with M8 connector (non-flush)

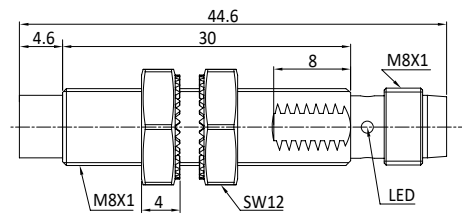

Fig. 5 Inductive sensor with M12 connector (flush)

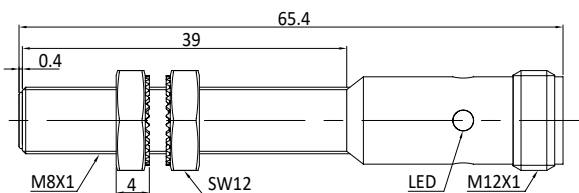
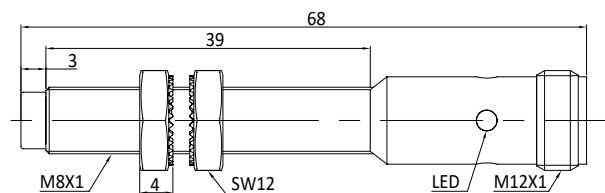

Fig. 6 Inductive sensor with M12 connector (non-flush)



G08 SERIES

WIRING DIAGRAMS (Note: 1 / 2 / 3 / 4 connector and terminals pin number Bn / Bu / Wh / Bk cable color)

WD1 DC 2-wire NO

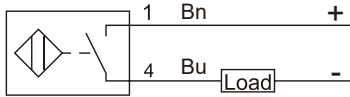

WD2 DC 2-wire NC

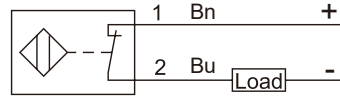

WD3 AC 2-wire NO

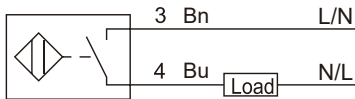

WD4 AC 2-wire NC

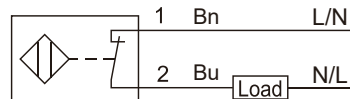

WD5 AC / DC 2-wire NO

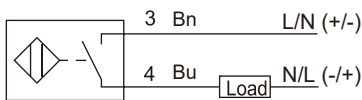

WD6 AC / DC 2-wire NC

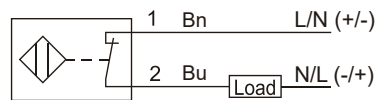

WD7 DC 3-wire PNP NO

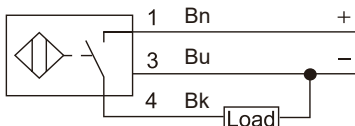

WD8 DC 3-wire NPN NO

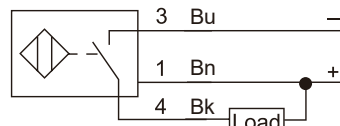

WD9 DC 3-wire PNP NC

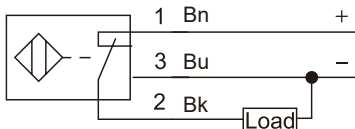

WD10 DC 3-wire NPN NC

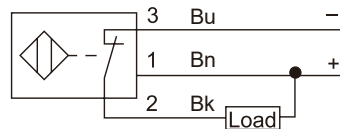

WD11 DC 4-wire PNP NO + NC

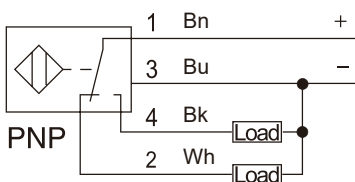

WD12 DC 4-wire NPN NO + NC

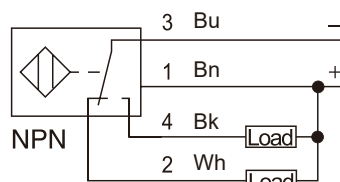

G08 SERIES

WIRING DIAGRAMS (Note: 1 / 2 / 3 / 4 connector and terminals pin number Bn / Bu / Wh / Bk cable color)

WD13 AC/DC 4-wire NO+NC

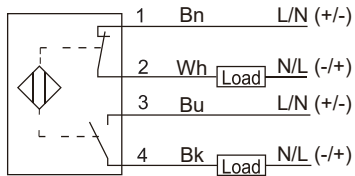

WD14 NAMUR 2-wire NC

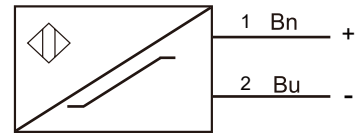

WD15 DC 4-wire 0-10V+0-20mA

